

Flexible Space
Management Solutions
Flexible Space
Management Solutions



Clearly Visionary Movable Glasswalls

— Frameless Glasswalls —

— Acoustic Glasswalls —

— Weather Resistant Glasswalls —



GIBCA

جيسكا

GIBCA LIMITED COMPANY (FZC) LLC
OMAN

Frameless
Glasswalls

Restaurants
Restaurants

Showrooms
Showrooms

Offices
Offices



GIBCA



جيسكا

Banks
Banks

Store Fronts
Store Fronts

HUFCOR

Weather
Resistant Glasswall

Receptions
Receptions

Resorts
Resorts

Shopping Malls
Shopping Malls



GIBCA



جيسكا

Hotels
Hotels

Clubs
Clubs

Residential
Residential

HUFCOR

HUFCOR PRODUCTS ARE MANUFACTURED BY GIBCA FURNITURE INDUSTRY UNDER LICENSE FROM HUFCOR INC. USA

GIBCA



جيسكا

Range of movable glasswalls from **Gibca**

Maximum freedom of design

As intelligent, cost-effective space utilization has become the order of the day, work practices and office design are rapidly evolving to maximize the utility of space.

Thanks to the virtually unlimited layout possibilities, Gibca's range of glasswalls can be designed to fit into any architectural concept. Whether the sliding wall is manually or automatically operated, Gibca has an option available to fit any design requirement.

Gibca's extensive coverage throughout the Middle East & North African region, providing sales and technical support right from the design and specification stage, also provides local service and installation.



HUFCOR
FRAMELESS GLASSWALL



HUF COR FRAMELESS GLASSWALL

No Visual Barriers

Hufcor frameless glasswalls serve as the perfect solution for transparent barrier to close up shop fronts, restaurants, delis or ATM areas while maintaining a full view of the entire outlets.

TECHNICAL DETAILS

Overhead Track and Carrier system:

Made of extruded Aluminium Alloy the track has been life cycle tested for about 10 yrs of use.

Zero maintenance & smooth operation even when site conditions require segmented tracks.

Top and bottom sweep seals ensure dirt free interiors.

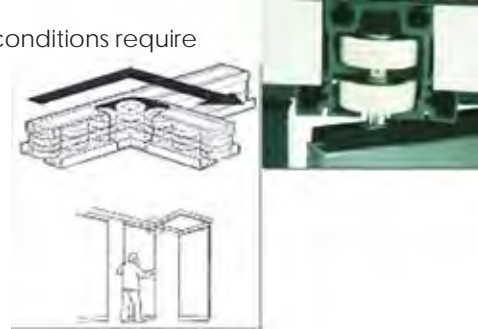

Glass options help you add your signature touch:

Sandblasting

Etching

Ceramic printing etc

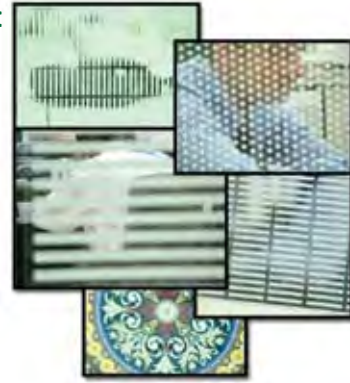

Stunning new tapered looks

Sleek Aluminium profile design avoids cover plates preventing dislodging.

End Caps enable each panel to be individually finished besides concealing mechanisms and protecting the glass.

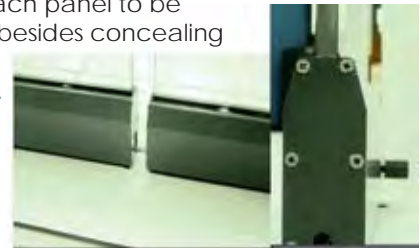

Unique Floor Bolt design

Allows each panel to be locked individually.

Facilitates vertical interlock between panels for greater security and partition stability.

Faster set-up and secure locking of panels.

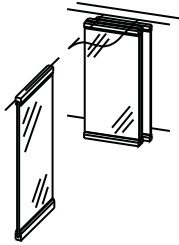

INDIVIDUAL OMNI DIRECTIONAL PANELS

Individual Panels are top supported by two (2) carriers that operate in the track system allowing panels to move and turn effortlessly through 90° degree intersections engineered for heavy glass panels. The versatility of stack arrangements includes Perpendicular Stack, Parallel Stack, Remote or Custom Stack.

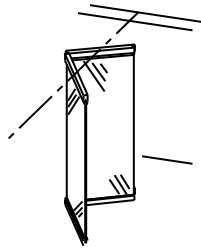

HINGED PAIRS / CENTER STACKING PANELS

Panels are hinged in pairs and are top-supported by one (1) carrier in each panel. The Center Stack arrangement provides panel storage at one or both ends of the walls installed position.

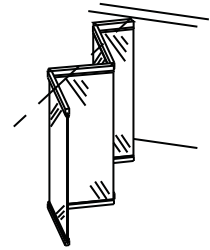

CONTINUOUSLY HINGED CENTER STACKING TRAINS – MANUAL & AUTOMATIC

Continuously Hinged Panels form a panel train allowing for easy set-up. The stacking arrangement can be at one end or bi-parting. The final closure panel can be a flipper or might just use a pivot panel at stack end. Partition operation can be manual or motorized (fully automatic).

PANEL CONSTRUCTION

Series 3630 panels are nominally 40 mm thick and up to 1100 mm in width. Panel faces are of 12 mm fully tempered glass. The glass is mechanically attached to top and bottom rails and does not rely on friction and adhesives.

Weight of the panels is approximately 36.12 Kg per sq. m for 12 mm glass.

The system is manually operated. The panels are moved from the storage area, positioned in the opening, and floor bolts set. The final closure can be secured by the following options:

1. Flipper Panel
2. Pivot panel with handle
3. Overlapping the opening
4. Pocket door

SUSPENSION SYSTEM

Hufcor track systems have been life-cycle tested for up to 161 Km or approximately 10 years of use.

FINISHES

The horizontal rails and track finish are clear anodized aluminium, however custom anodizing - bronze or champagne is available on request. Frames can also be powder-coated to desired RAL color. Specialty or Art glass can also be integrated with the system as an option.

WARRANTY

Track, carriers, and horizontal rails are guaranteed for two years against defects in material and workmanship. The glass is not included in this warranty.

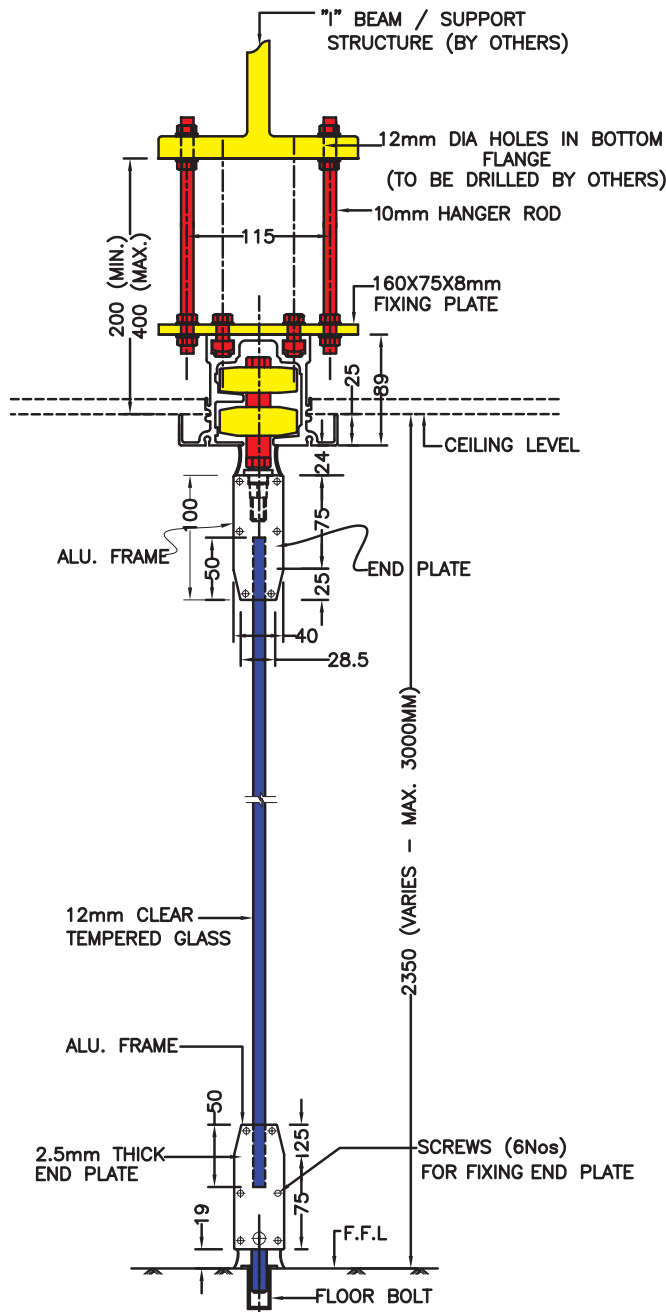

TYP. VERTICAL SECTION
SCALE 1:5

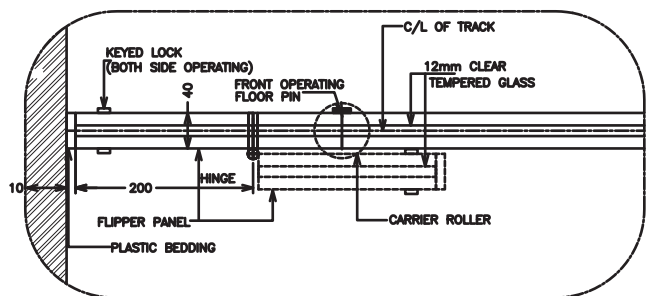
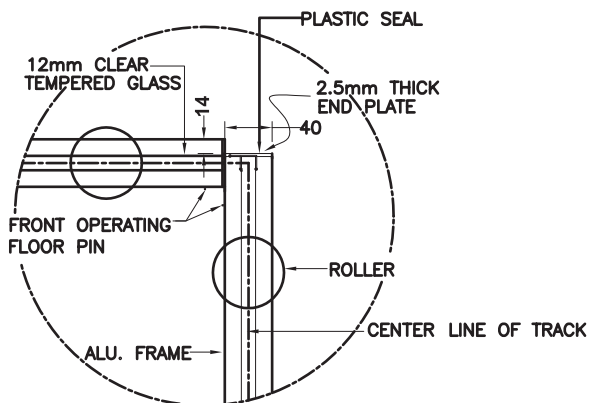

ACOUSTIC
GLASSWALLS



HUFCOR
ACOUSTIC GLASSWALL



HUFCOR ACOUSTIC GLASSWALL – SERIES 5631

Close out the noise – not the view!

Hufcor acoustic Glasswalls are an effective barrier to sound without blocking out the view.

TECHNICAL DETAILS

Sealed double Glazed Unit:

The 20 mm air space acts as an effective sound barrier. This, coupled with vertical tongue and groove joint and mechanical seal, enables these Glasswalls to achieve STC rating of up to 46 STC.



Fixed Top Vinyl Sweep Seals Bottom Mechanical Seal

Can be activated by a simple half turn of the handle.

Designed to accommodate out of level floors.

Applies uniform pressure against the floor for effective acoustic sealing and stable partitioning.



The panels have been tested for sound control by an independent laboratory and can achieve ratings up to 44 STC depending on thickness and configurations available.

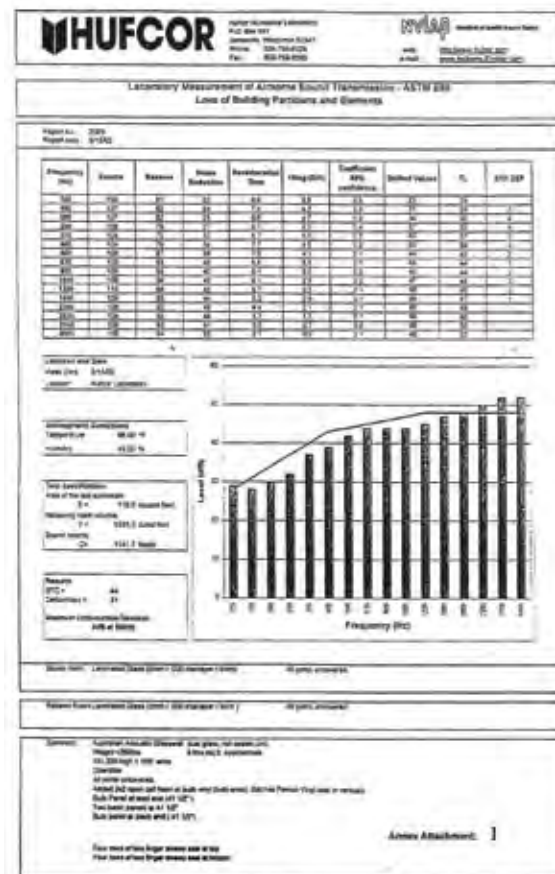

ACOUSTIC GLASSWALLS

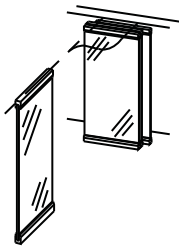

INDIVIDUAL OMNI DIRECTIONAL PANELS

Individual Panels are top supported by two (2) carriers that operate in the track system allowing panels to move and turn effortlessly through 90° degree intersections engineered for heavy glass panels. The versatility of stack arrangements includes Perpendicular Stack, Parallel Stack, Remote or Custom Stack.

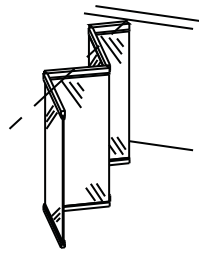

CONTINUOUSLY HINGED CENTER STACKING TRAINS – MANUAL & AUTOMATIC

Continuously Hinged Panels form a panel train allowing for easy set-up. The stacking arrangement can be at one end or bi-parting. The final closure panel can be a flipper or might just use a pivot panel at stack end. Partition operation can be manual or motorized (fully automatic).

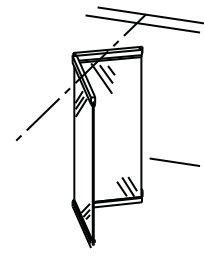

HINGED PAIRS / CENTER STACKING PANELS

Panels are hinged in pairs and are top-supported by one (1) carrier in each panel. The Center Stack arrangement provides panel storage at one or both ends of the walls installed position.

PANEL CONSTRUCTION

Series 5631 SDGL panels are nominally 75 mm thick and up to 1100 mm in width. Panel faces are sealed, double glazed units 10.76 mm and 6.76 mm laminated, insulated clear glass with a 20 mm spacer filled with silica gel crystals. The frames are made of aluminum alloy 6063-T6 with extruded aluminum trim to protect the edge of the glass. Vertical interlock between panels is via deep nested tongue and groove configuration resulting in more stability, ease of alignment and better sound seal.

SUSPENSION SYSTEM

Hufcor track systems have been life-cycle tested for up to 161 Km or approximately 10 years of use. Track is made of clear anodized architectural grade extruded aluminum alloy 6063-T6 and is designed to provide integral support for adjoining ceiling, soffit, or plenum sound barrier.

SEALS

Horizontal top seals are continuous contact multiply vinyl while the bottom horizontal seals incorporate a mechanical seal manually operated by a handle inserted in the panel stile. Turning the handle through 170 degrees simultaneously extends or retracts the seal through an overthrow cam mechanism, which firmly holds the seal in the retracted or extended mode. Vertical edge of each panel incorporates two vinyl gaskets for better acoustic seal and interlock between panels.

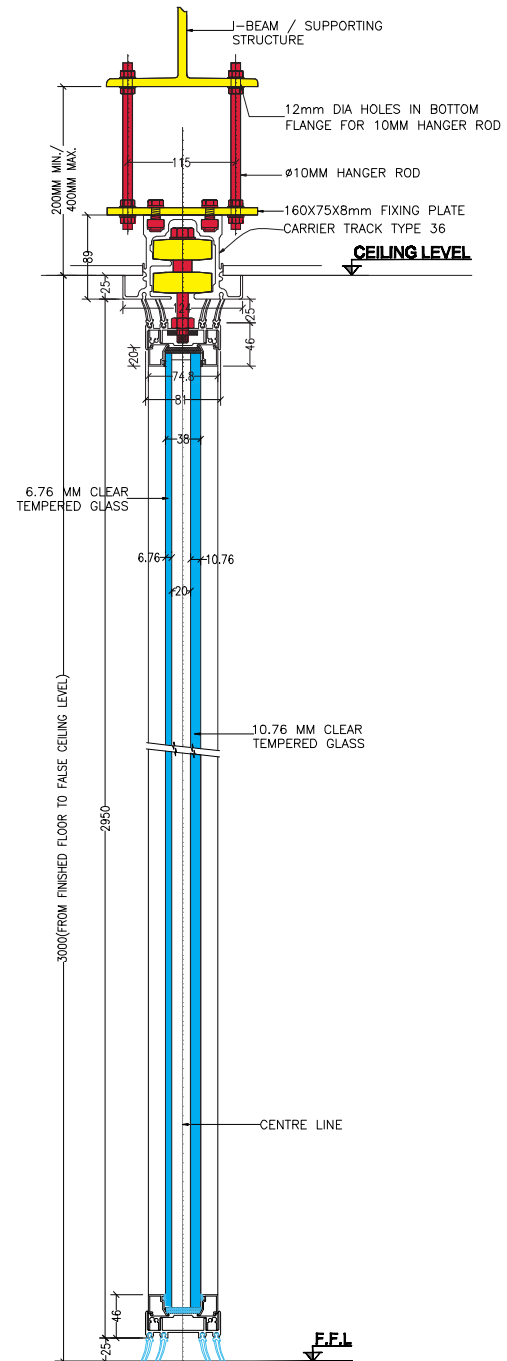

TYP. VERTICAL SECTION
SCALE: 1:8

FINISHES

The standard frame and track finish is clear anodized aluminium, however custom anodizing – bronze or champagne is available on request. Frames can also be powder-coated to desired RAL color. Specialty or Art glass can also be integrated with the system as an option.

The weight of the panels is approximately:

55 Kg / sq meter (UP TO 3000 MM STANDARD HEIGHT)

77.2 Kg/ sq meter with sealed, double pane units 6.76 mm and 10.76 mm laminated. (FOR GREATER HEIGHTS : UP TO 5000 MM MAXIMUM)

ACOUSTICAL PERFORMANCE

Hufcor shall guarantee in writing that the panel frame and seal system supplied shall conform to the panels tested in an independent Australian Testing Laboratory, in accordance with Testing Procedure: AS1191- 1985 up to 46 dB.

Acoustic performance of glass is dependent on thicknesses and configurations.

QUALITY ASSURANCE

- A. Glazing accordance with Australian Standard AS 1288-1994.
- B. STC (Sound Transmission Classification) achieved as per the standard AS1191 - 1985 test method.
- C. The manufacturing to ISO 9001 standards.

WARRANTY

Track, carriers, and frames are guaranteed for Two years against defects in material and workmanship. The glass is not included in this warranty.

Wall jamb

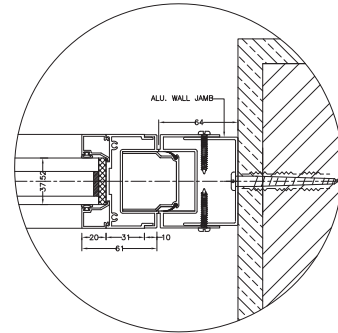

Panel joint

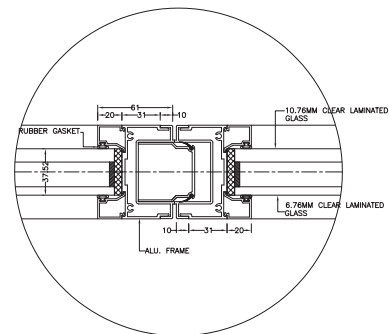

Stack End

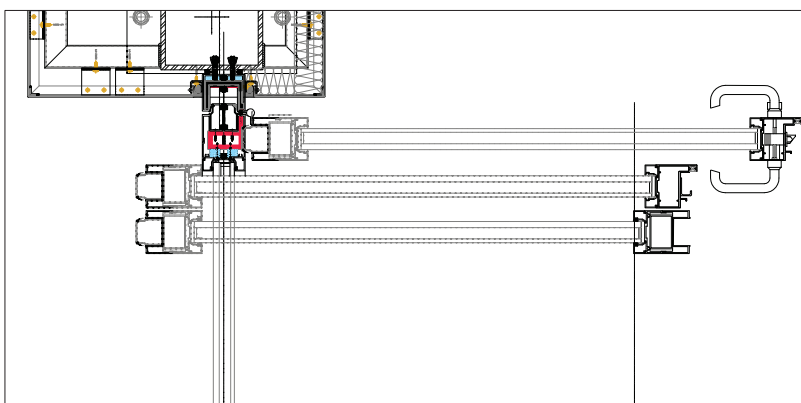

Door panel

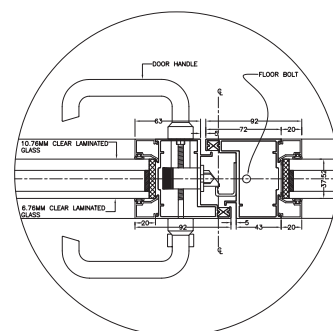

WEATHER RESISTANT
GLASSWALLS



HUFCOR
WEATHER RESISTANT
GLASSWALL

HUF COR WEATHER RESISTANT GLASSWALL – SERIES 5631WR

Bring the outdoors inside

Hufcor Weather Resistant glasswalls utilize our proven tracking systems along with special Hufcor (WR) extrusions which provide a positive interlocking stile and weather seal between panels. The panels can be glazed either as single glazed units or sealed double glazed units. The panels can incorporate various height mid-rails or muntin bars for a French door effect.

TECHNICAL DETAILS

Patented Capacity Certified Overhead Track and Carrier system:

Twin Rollers provide greater stability to the panels and enables the panels to easily negotiate turns and bends.



Sealed double Glazed Unit:

The inner face of the outer pane carries a thin film for UV protection. The 20 mm air space effectively insulates against external environment resulting in reduced air conditioning or heating costs and also acts as an effective sound barrier.



Vertical Aluminium extrusions incorporate a tongue and groove joint creating:

- Positive interlock
- Stability
- Ease of panel alignment
- Draft and weather resistance



Top and Bottom Sweep Seals:

Ideal for semi-exposed locations, it forms a barrier against the weather elements while maintaining inside temperature and humidity levels.

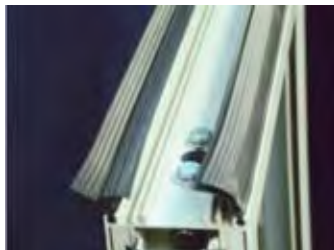

Retractable Bottom Seal



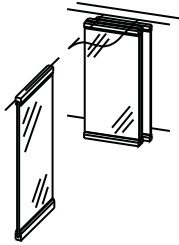

INDIVIDUAL OMNI DIRECTIONAL PANELS

Individual Panels are top supported by two (2) carriers that operate in the track system allowing panels to move and turn effortlessly through 90° degree intersections engineered for heavy glass panels. The versatility of stack arrangements includes Perpendicular Stack, Parallel Stack, Remote or Custom Stack.

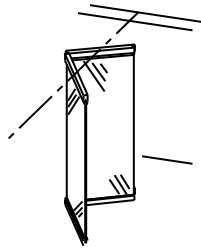

HINGED PAIRS / CENTER STACKING PANELS

Panels are hinged in pairs and are top-supported by one (1) carrier in each panel. The Center Stack arrangement provides panel storage at one or both ends of the walls installed position.

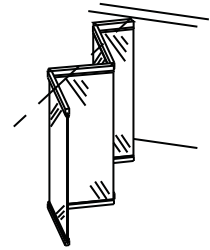

CONTINUOUSLY HINGED CENTER STACKING TRAINS

Continuously Hinged Panels form a panel train allowing for easy set-up. The stacking arrangement can be at one end or bi-parting. The final closure panel can be a flipper or might just use a pivot panel at stack end.

PANEL CONSTRUCTION

Series 5631WR panels are nominally 75 mm thick and up to 1100 mm in width. Panel faces are sealed, double-pane units 12 mm clear laminated glass and 6 mm clear tempered glass with a 20 mm spacer filled with silica gel crystals. The Sealant is UV and moisture resistant for additional protection against weather elements. The frames are of aluminum alloy 6063-T6 with extruded aluminum trim to protect the edge of the glass. All weather resistant 5000 series frames are made of thermally broken extended aluminium profile PVDF coated to standard RAL colors All frames are steel reinforced for stability against wind pressure. The Vertical interlock between panels is via deep nested tongue and groove configuration resulting in more stability, ease of panel alignment and better sound seal.

SUSPENSION SYSTEM

Hufcor track systems have been life-cycle tested for up to 161 Km or approximately 10 years of use. Track is of architectural grade extruded aluminum alloy 6063-T6 and is designed to provide integral support for adjoining ceiling, soffit, or plenum sound barrier. The track is triple PVDF coated to standard RAL color for protection. All Fixing accessories are made from architectural grade 316 Stainless steel.

SEALS

Horizontal top and bottom seals are UV stabilized, continuous contact, multi ply seals in brown colour. The bottom horizontal seals incorporate extruded aluminium box section and are manually operated. Turning the handle through 170 degree simultaneously extends or retracts the seal through an overthrow cam mechanism, which firmly holds the seal in the retracted or extended mode. Top supporting horizontal rails are steel reinforced aluminium and incorporate sweep seals. Bottom horizontal rail is made from 6063-T6 aluminium and incorporates a retractable mechanical seal.

FINISHES

The standard frame and track finish is clear anodized aluminium However, custom anodizing – bronze or champagne is available on request. Frames can also be powder-coated to desired RAL color. Specialty or Art glass can also be integrated with the system as an option.

Weight of the panels is approximately:
61 Kg / sq meter with sealed, double pane units 6 mm and 12 mm Clear Tempered glass.

QUALITY ASSURANCE

- A. The glazing is in accordance with Australian Standard AS 1288-1994.
- B. The system is designed for the wind pressures to comply with AS1170.2 Terrain Category.
- C. The manufacturer has a quality system that is registered to the ISO 9001 standards.

WARRANTY

Track, carriers, and frames are guaranteed for Two years against defects in material and workmanship. The glass is not included in this warranty.

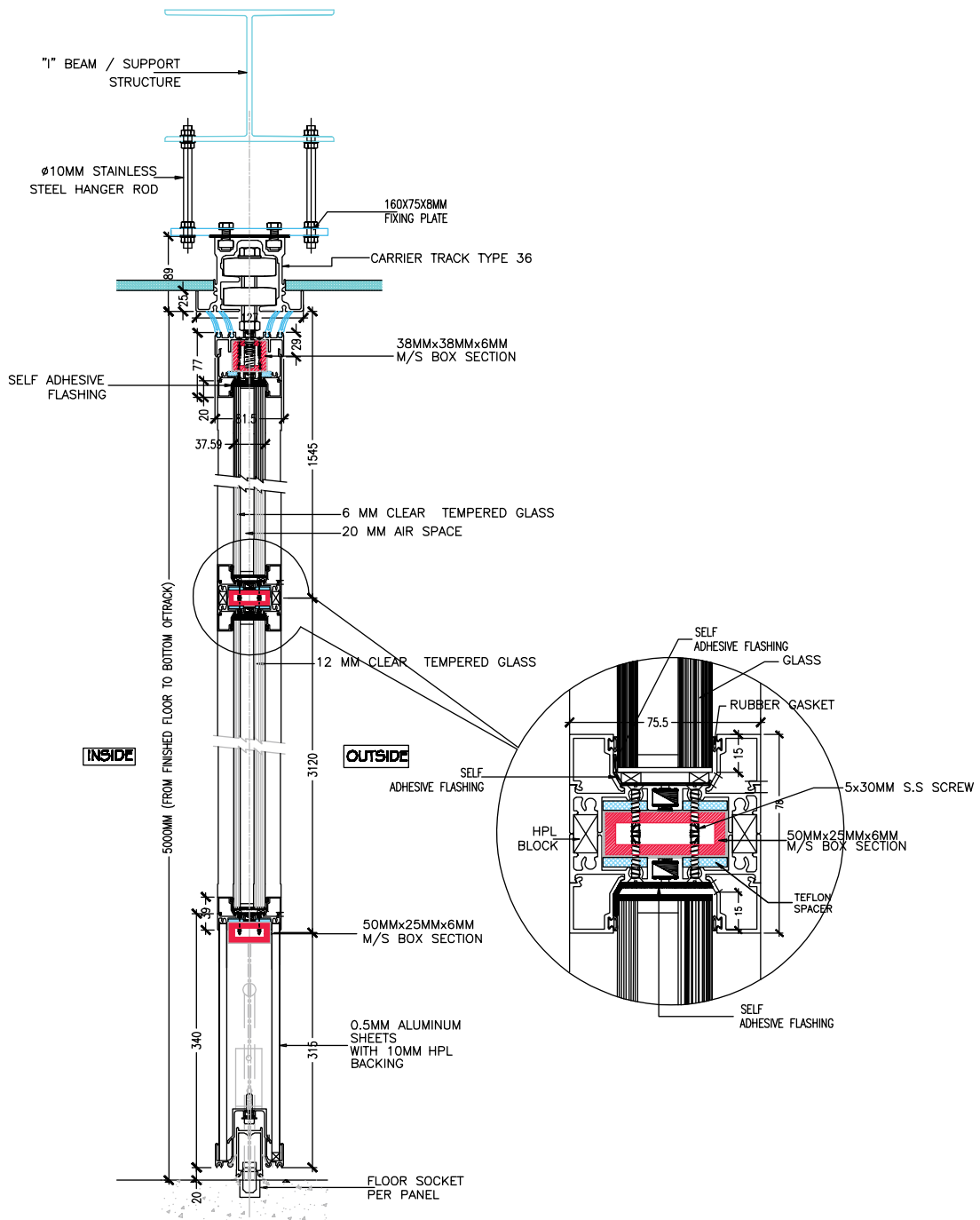

VERTICAL SECTION OF PANELS
SCALE 1:4

WEATHER RESISTANT
GLASSWALLS



GIBCA
Wet Area Cubicles, Locker Systems
& Internal Wall Cladding



GIBCA
Office Partition Systems

WE KNOW THE BUSINESS.
COUNT ON US FOR THE RIGHT SOLUTION.



GIBCA



جی بی سی

GIBCA LIMITED COMPANY (FZC) LLC

Address: P.O.Box 312, Postal Code 322, Sohar, **Sultanate of Oman**

Tel: + 968 2685 0261, **Fax:** + 968 2685 0285,

Email: info@gibcaoman.com, **Website:** www.gibcaoman.com